

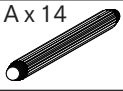







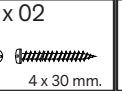
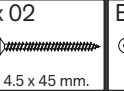
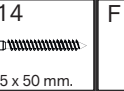
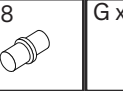

# K138

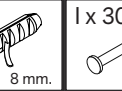
v.02

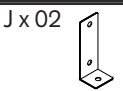
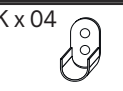
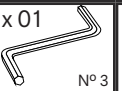

A x 14 	B x 18  3.5 x 15 mm.	C x 02  4 x 30 mm.	D x 02  4.5 x 45 mm.	E x 14  5 x 50 mm.	F x 08 	G x 06  8 mm.	H x 02 	I x 30 
J x 02 	K x 04 	L x 01  N° 3	M x 12  3 mm.					

## Option A

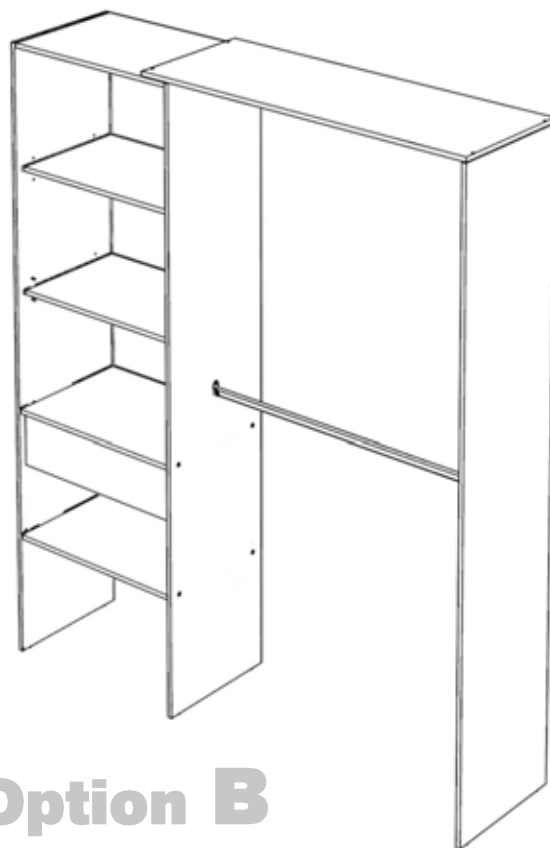
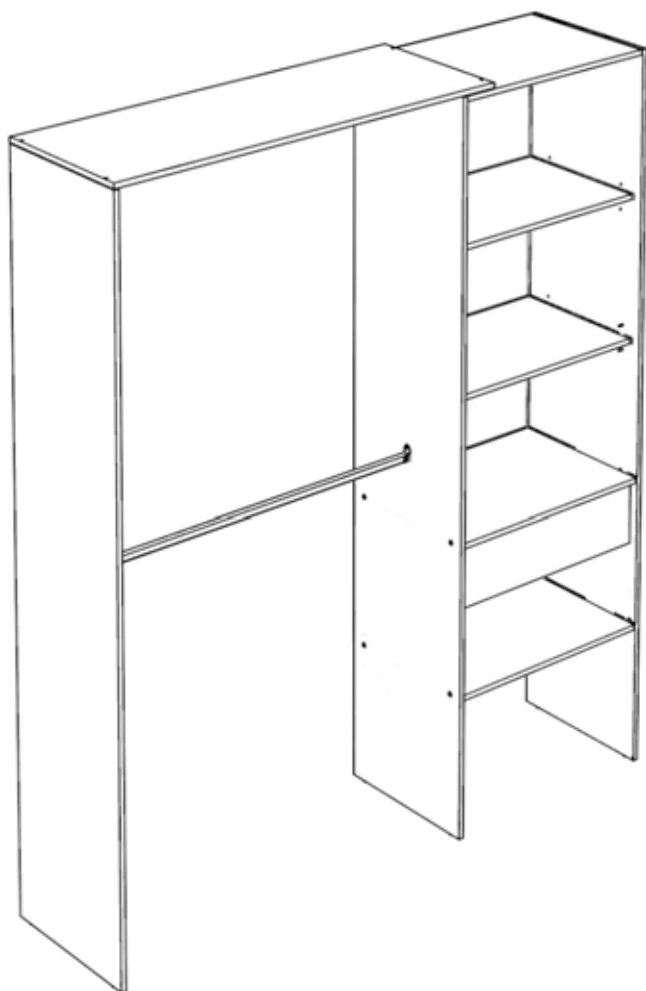

## Option B

### FR

#### CONSEILS DE MONTAGE CONSEILS POUR L'USAGE

Préparez les différents parts du meuble  
Regrouper et compter toute la quincaillerie  
Préparez l'outillage nécessaire  
Aménagez-vous une area de montage  
Faire le montage sur moquette afin de protéger le meuble des rayures  
Ne forcer pas le montage  
Évitez placer le meuble près des sources de chaleur  
Évitez utiliser de chiffons ou des produits de nettoyage pour ne pas rayer la superficie du meuble  
Meuble d'usage domestique pour l'intérieur de la maison.

### PT

#### RECOMENDAÇÕES PARA MONTAGEM E USO

Prepare todas as peças para a montagem de móveis  
Reagrupar e contar o hardware  
Preparar as ferramentas de montagem  
Preparar a área de montagem  
Montar as peças em um tapete para evitar riscos e danos na superfície dos móveis  
Não force as assembleias  
Não colocar móveis perto de fontes de calor  
Evitar o uso de panos, trapos ou produtos de limpeza que possam riscar o móvel.  
Móveis para uso doméstico no interior da casa.

### IT

#### CONSIGLI INSTALLAZIONE ED USO

Preparare tutti componenti del mobile per il montaggio  
Ordinare la ferramenta  
Preparare tutti gli attrezzi necessari per il montaggio  
Preparare l'area di montaggio  
Fare il montaggio su un tappeto per evitare danneggiare le superfici dei mobili  
Non forzare i componenti.  
Evitare posizionare il mobile in prossimità di fonti di calore  
Non usare panni né detersivi né solventi che possano danneggiare le superficie dei mobili  
Mobili per uso domestico all'interno della casa.

### DE

#### MONTAGEHINWEISE-GEBRAUCHSHINWEISE

Identifizieren Sie die Einzelteile  
Überprüfen Sie Die Anzahl der einzelnen Beschlagteile  
Legen Sie das notwendige Werkzeug bereit  
Bereiten Die Montagefläche  
Montieren Sie das Möbel auf einem Teppich , sauberen Untergrund  
Niemals die verbindungen zu start anziehen  
Nicht neben Wärmequellen platzieren  
Vermeiden Sie Tücher und keinesfalls scharfe oder ätzende Reinigungsmittel.  
Möbel für den Gebrauch im Haus geeignet.

### ES

#### RECOMENDACIONES MONTAJE Y USO

Agrupe y cuente el herraje.  
Prepare todas las piezas para el montaje del mueble.  
Tenga preparadas las herramientas para el montaje.  
Prepare la zona del montaje.  
Monte el mueble sobre una moqueta para evitar rayar y dañar la superficie del mueble.  
No fuerce los ensamblajes.  
Evite colocar el mueble cerca de fuentes de calor.  
Evite utilizar trapos, paños o productos de limpieza que puedan dañar la superficie del mueble.  
Mueble para uso doméstico en interior de vivienda.

### EN

#### RECOMMENDATIONS FOR ASSEMBLY AND USE

Prepare all the parts of the furniture  
Group and count all the hardware  
Prepare all the tools for the assembly.  
Clear and prepare the assembly area.  
Do the assembly on a carpet to avoid damaging the surface of the furniture  
Avoid forcing the fittings  
Avoid placing the Furniture near any heating source  
Do not use cloths or cleaning products to avoid damaging the surface of the furniture  
Indoor furniture.Suitable for domestic use.

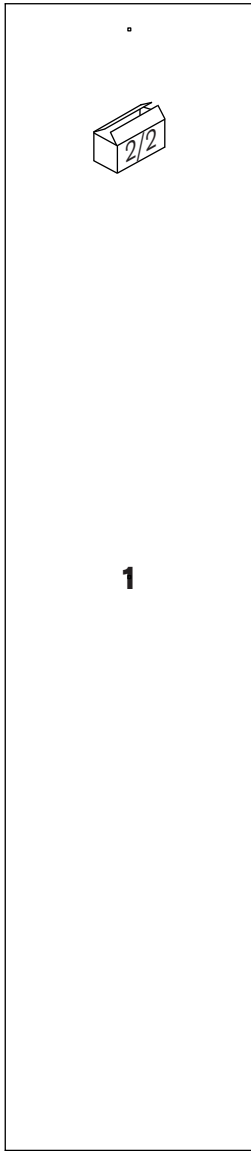

1

399 x 1850 mm.

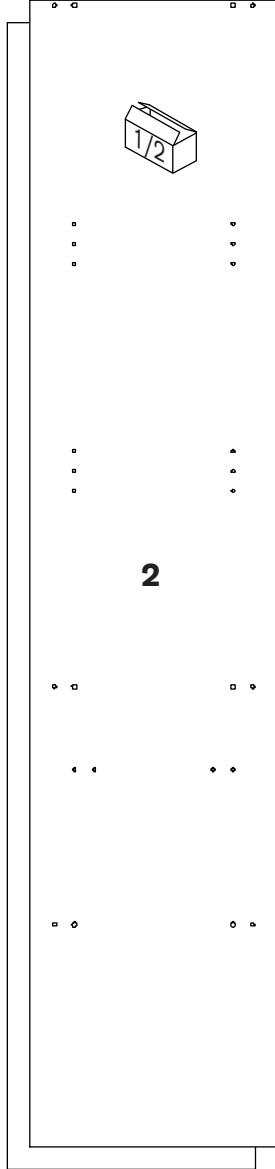

2

399 x 1850 mm.

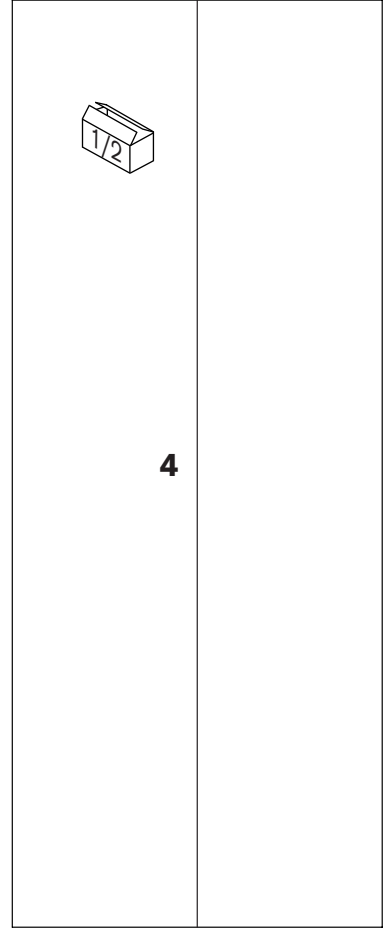

4

598 x 1499 mm.

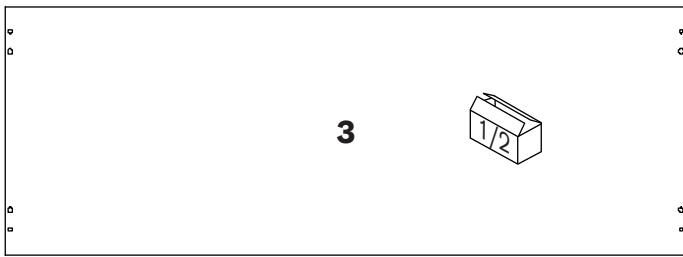

3

1100 x 400 mm.

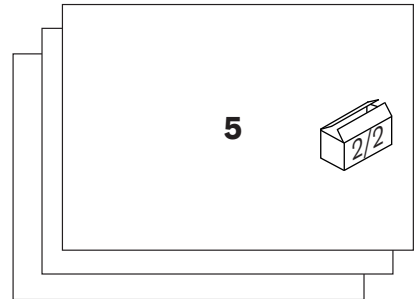

5

569 x 398 mm.

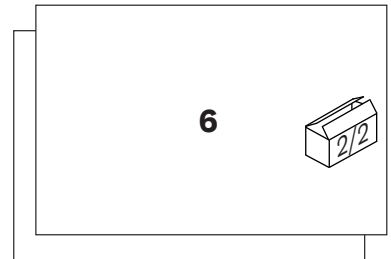

6

569 x 370 mm.

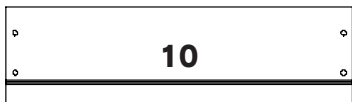

10

563 x 157 mm.

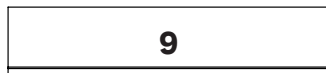

9

520 x 110 mm.

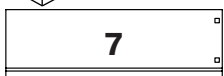

7

350 x 110 mm.

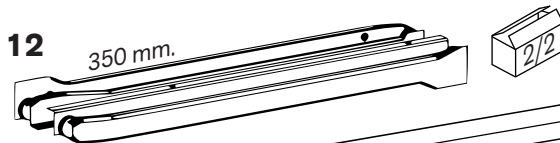

12

350 mm.

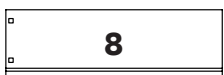

8

350 x 110 mm.



13

977 mm.

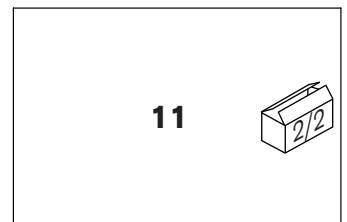

11

531 x 351 mm.



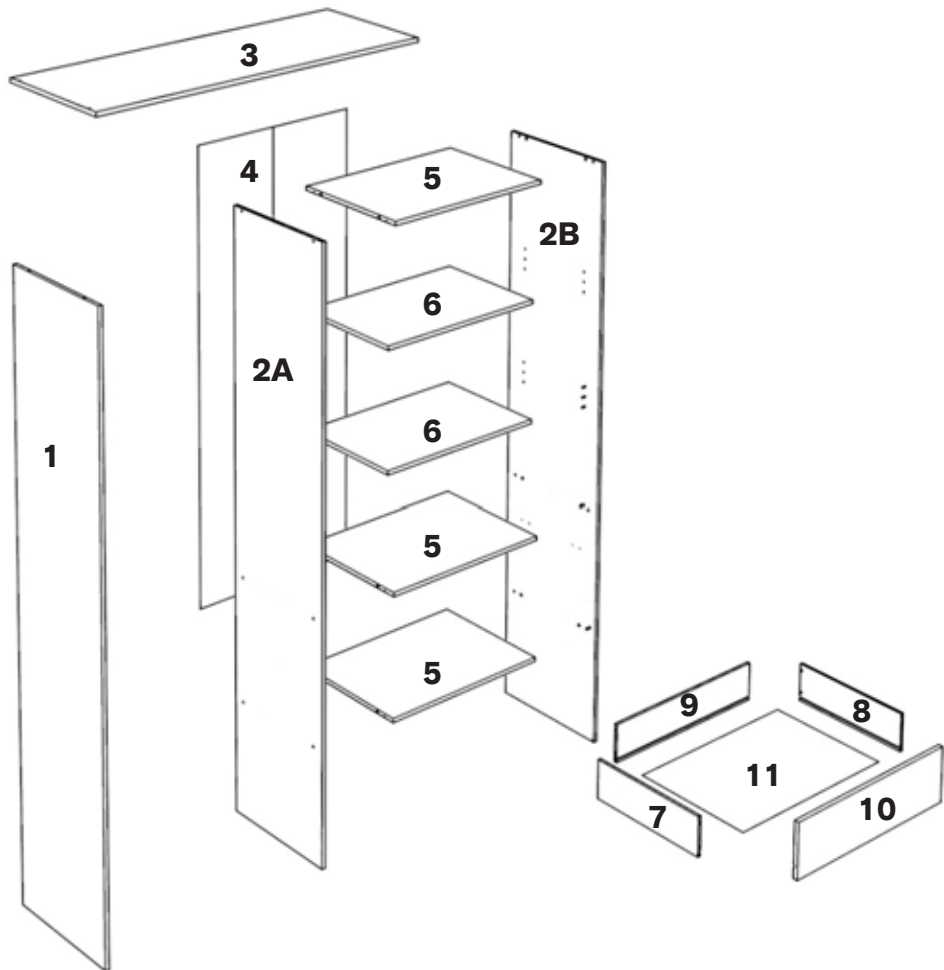

1

A x 02

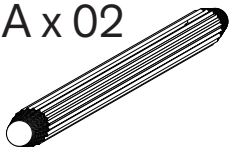

B x 04



3.5 x 15 mm.

K x 02

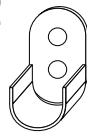

G x 02

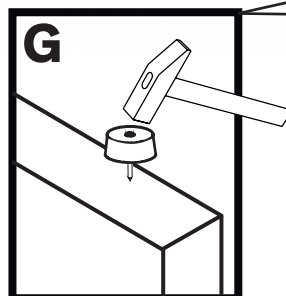
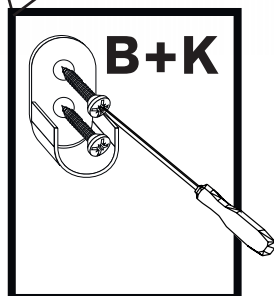
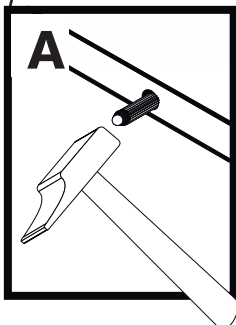
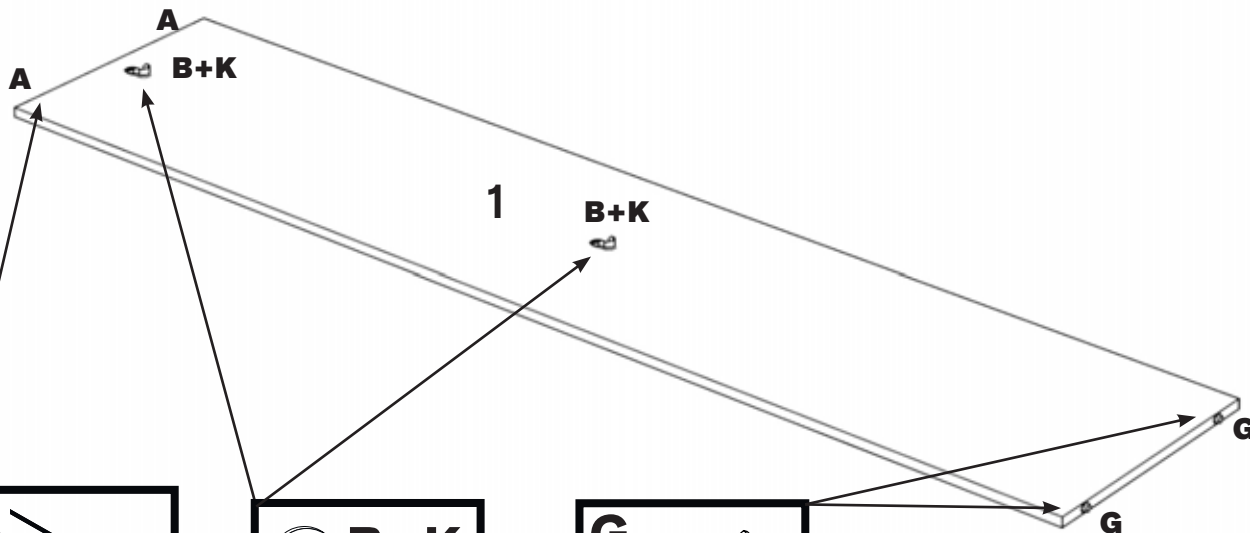

2

B x 02

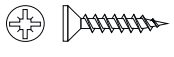

3.5 x 15 mm.

F x 04

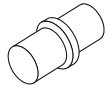

G x 02

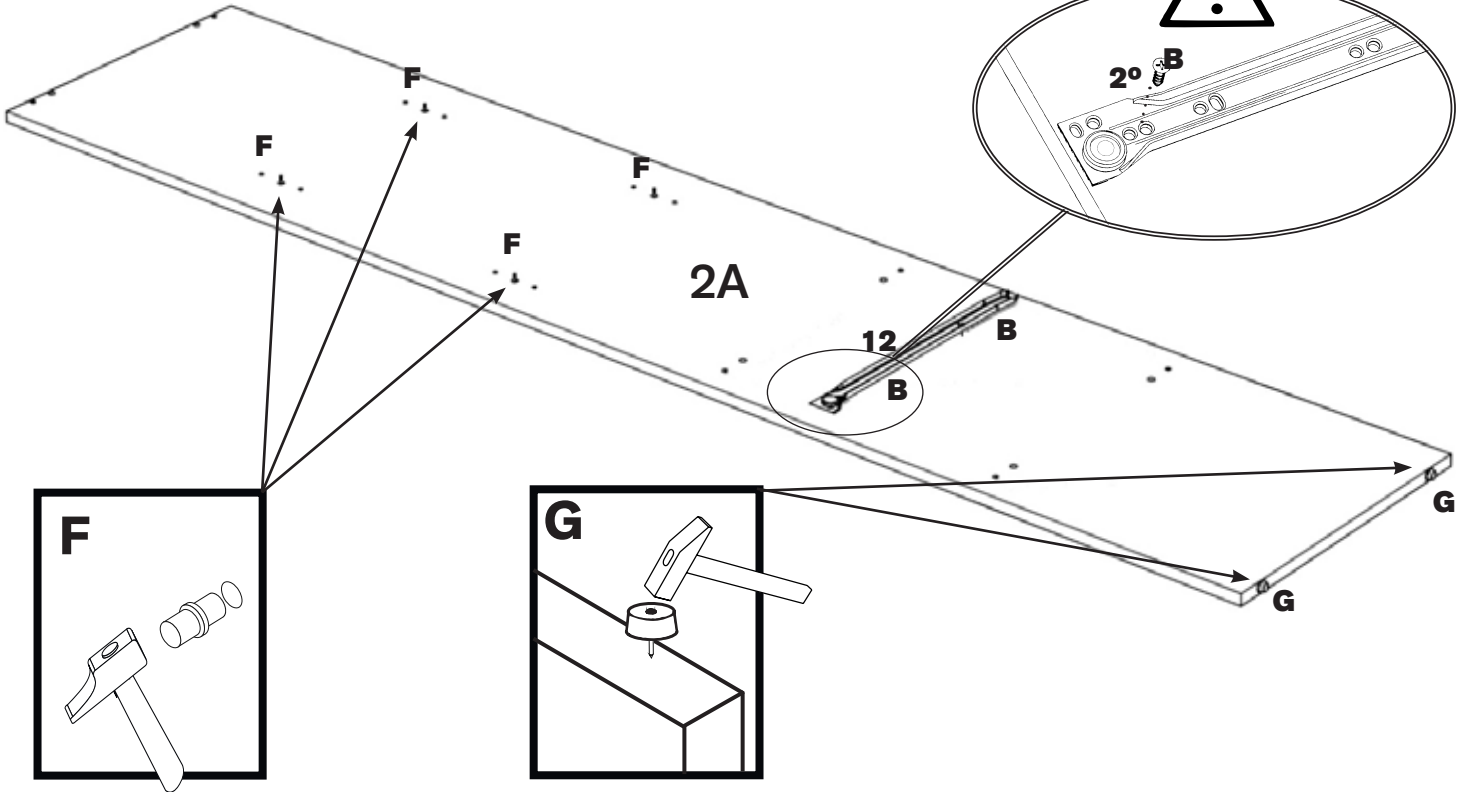
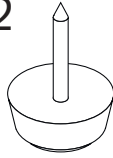

3

B x 02

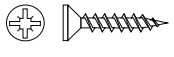

3.5 x 15 mm.

F x 04

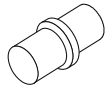

G x 02

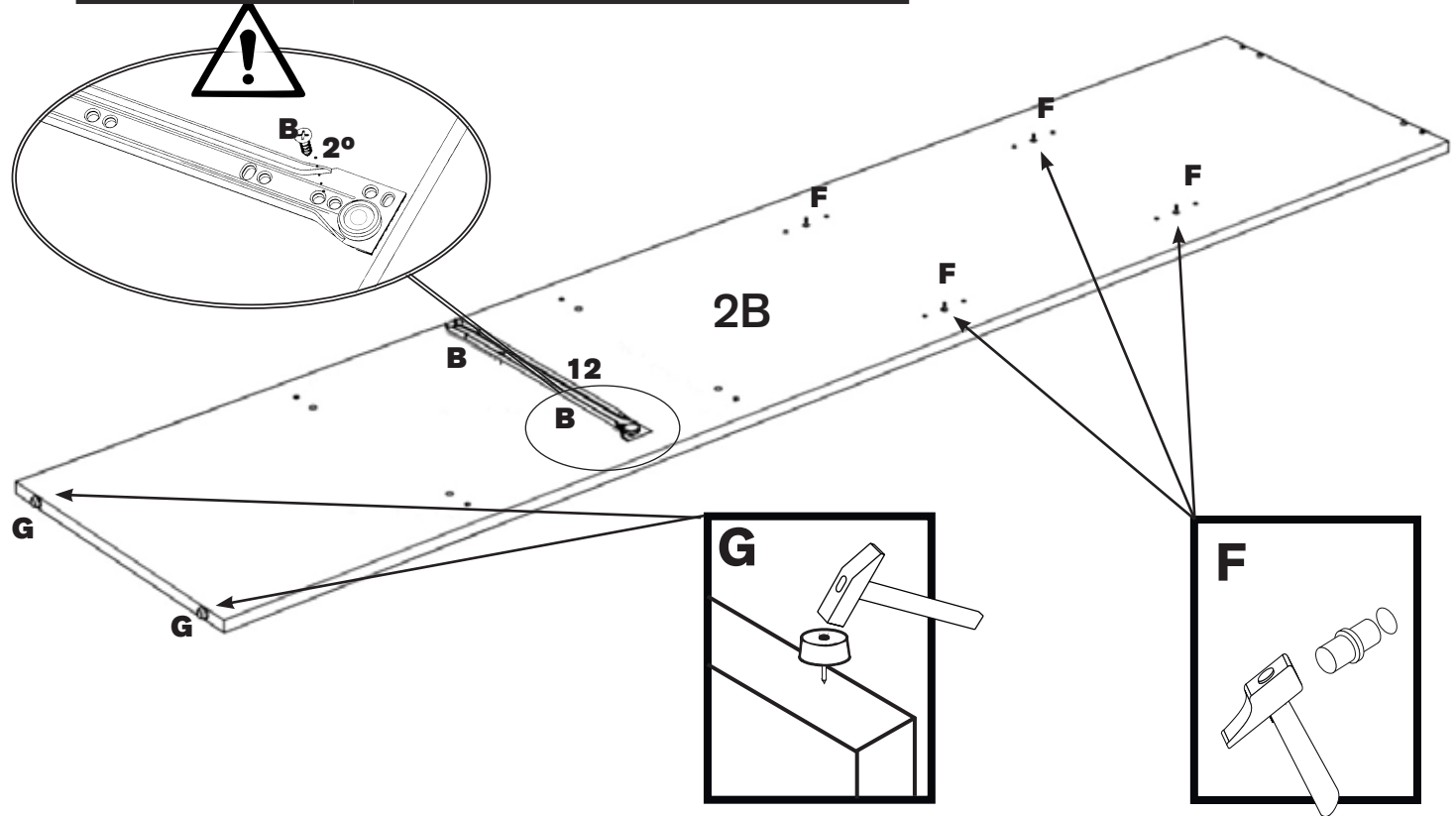
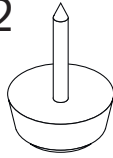

4 A x 12

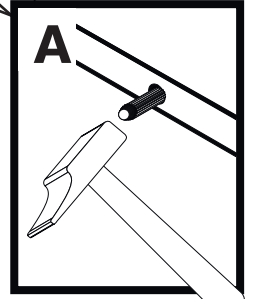
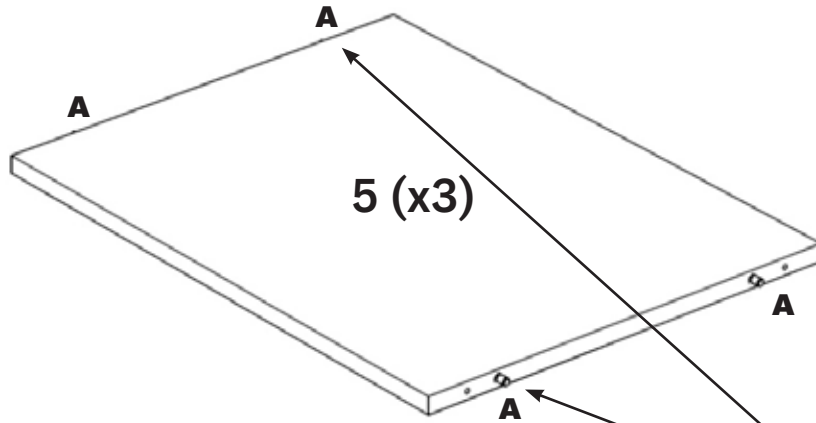
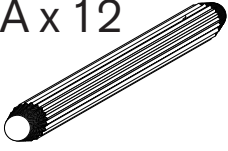

5

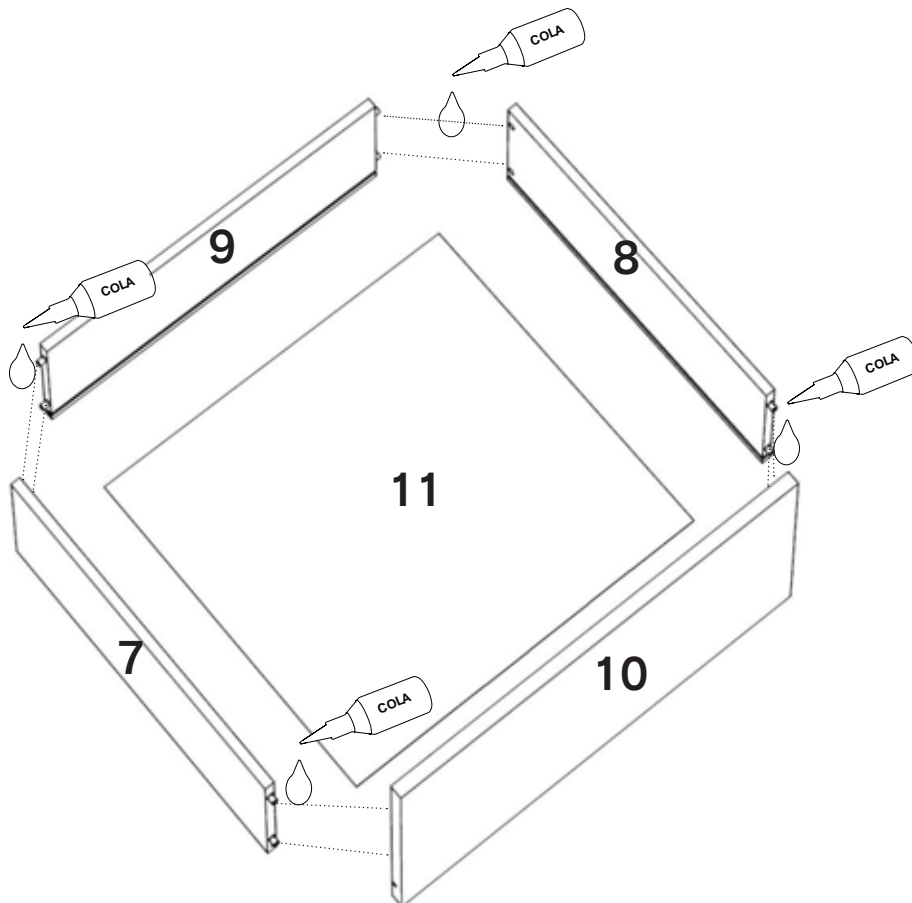

6 B x 04

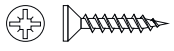

3.5 x 15 mm.

180°

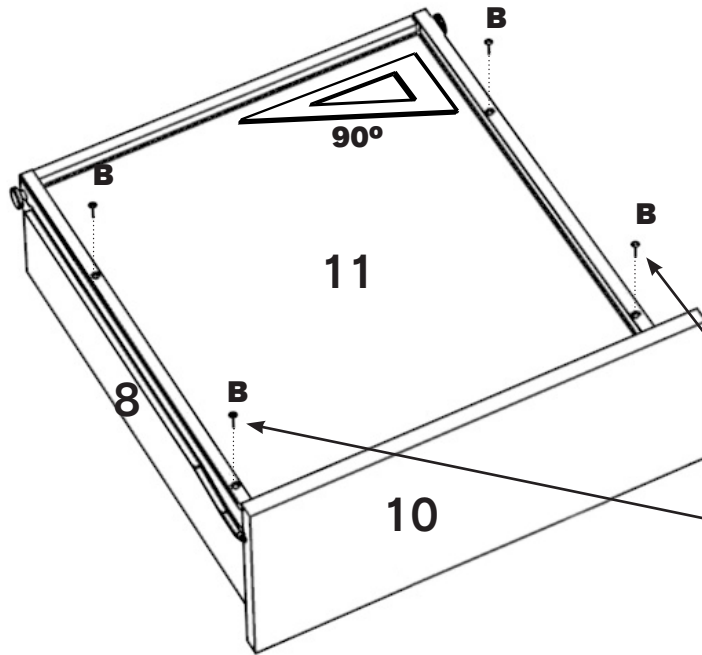

B



Secado 30m.  
Drying 30m.  
Secagem 30m.  
Séchage 30m.

7 E x 12



5 x 50 mm.

L x 01

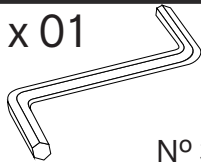

N° 3

M x 12



3 mm.

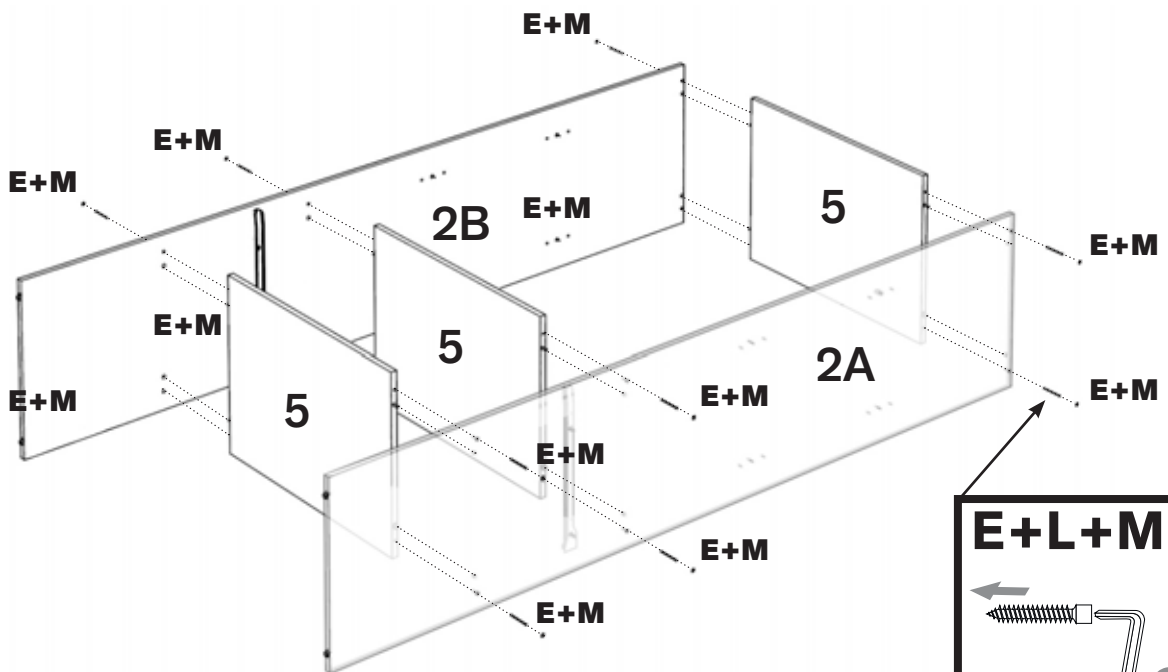

E+L+M

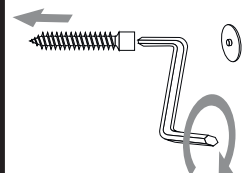

8

B x 04

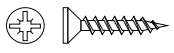

3.5 x 15 mm.

I x 30

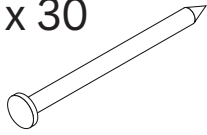

K x 02

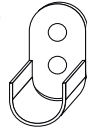

# Option A

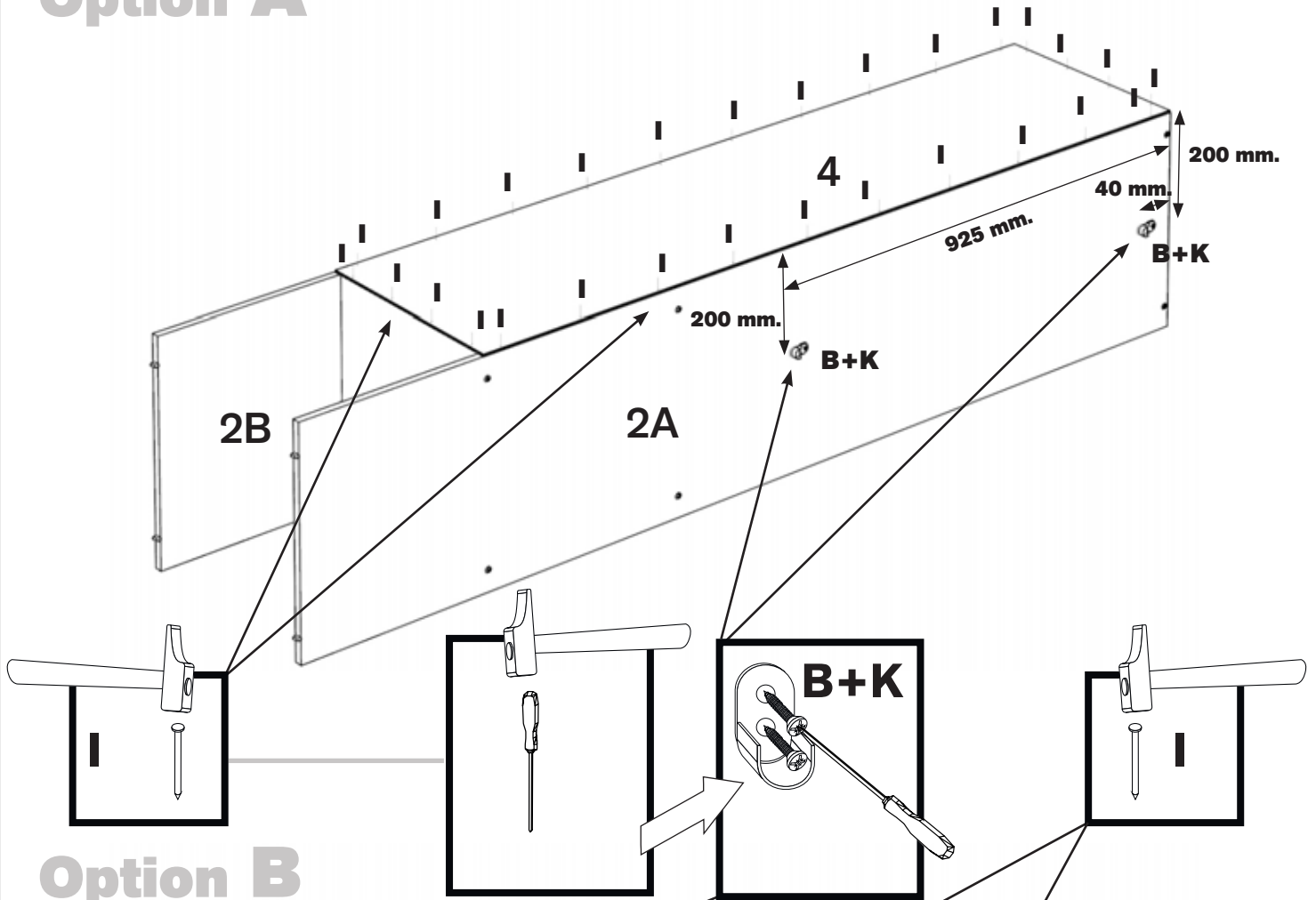

# Option B

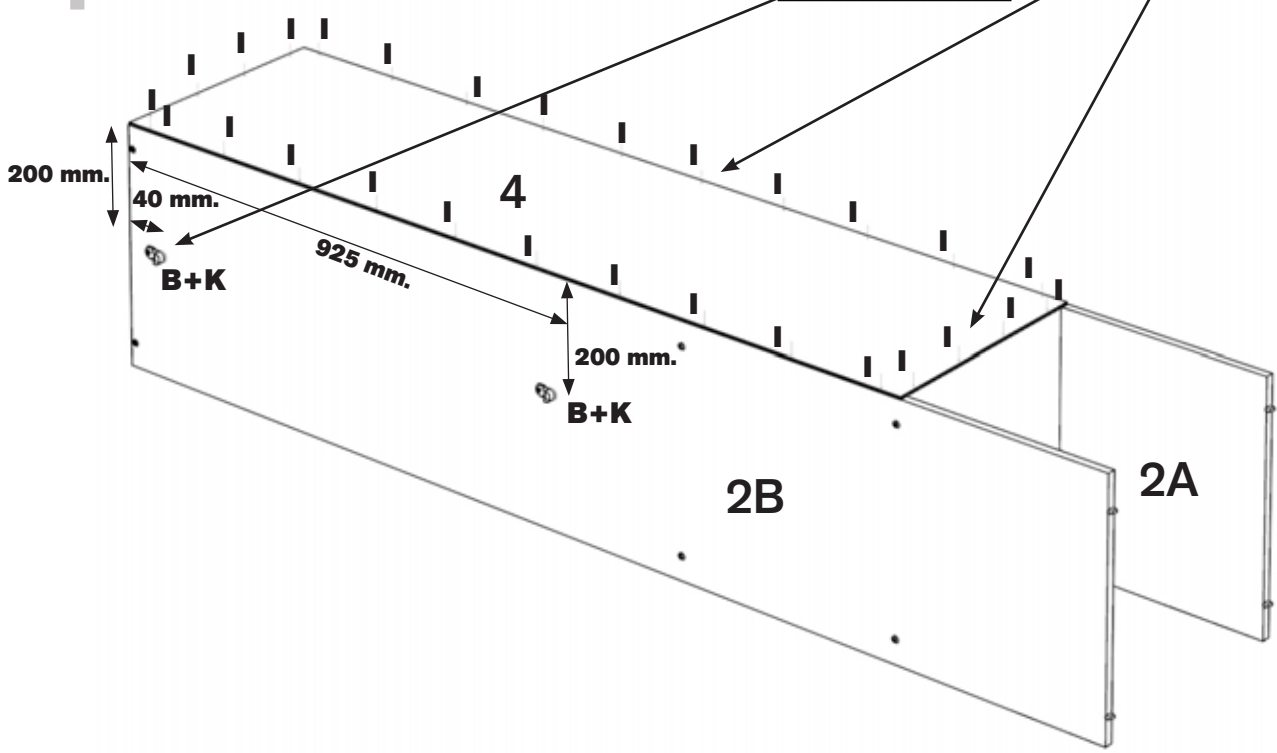

9

E x 02



5 x 50 mm.

L x 01

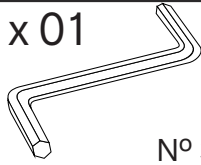

N° 3

## Option A

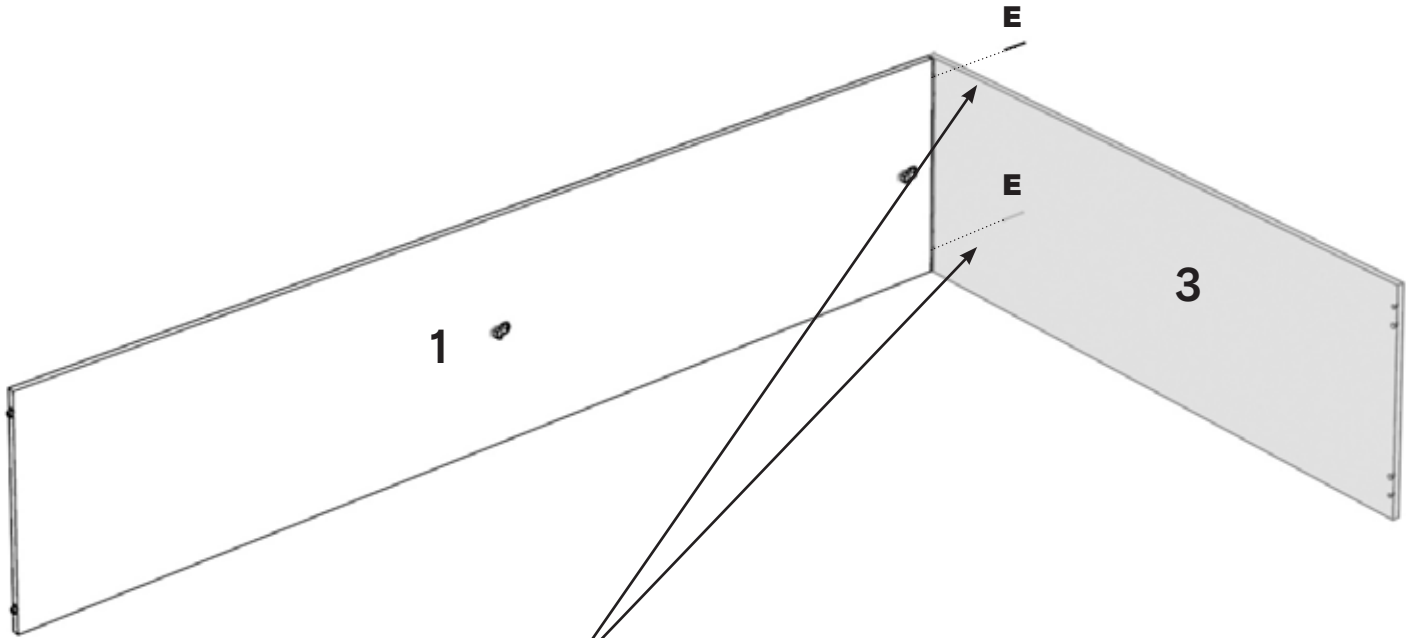

E+L

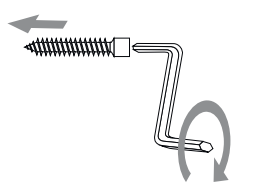

## Option B

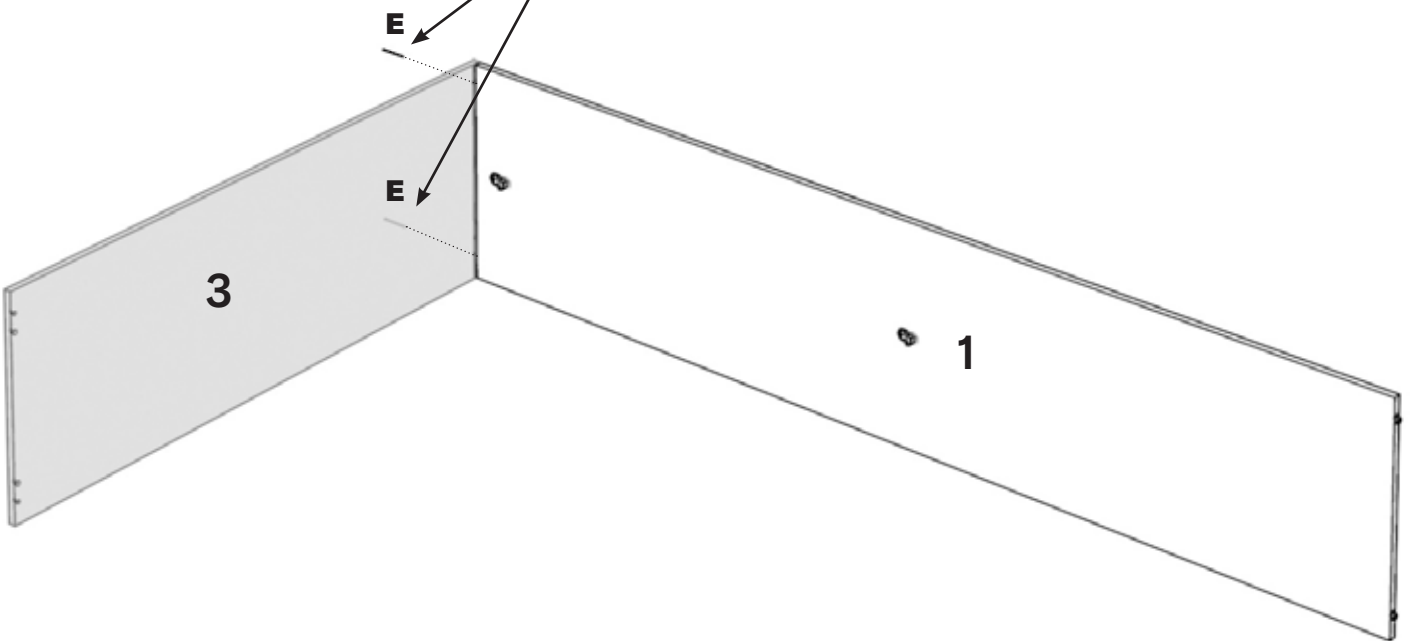



10

C x 02



### Option A

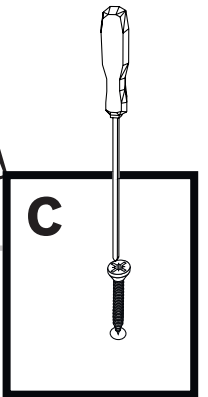
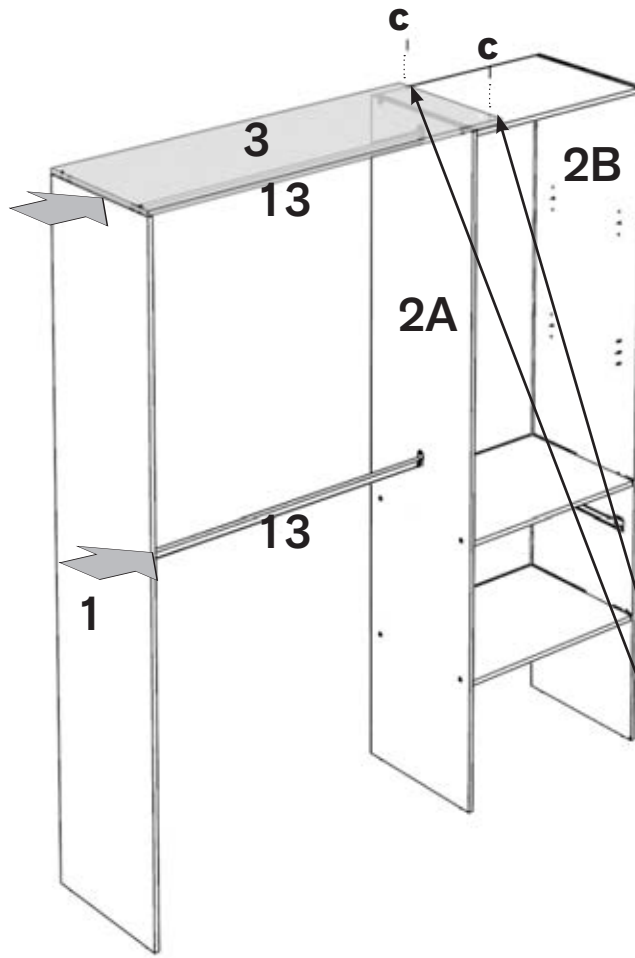

### Option B

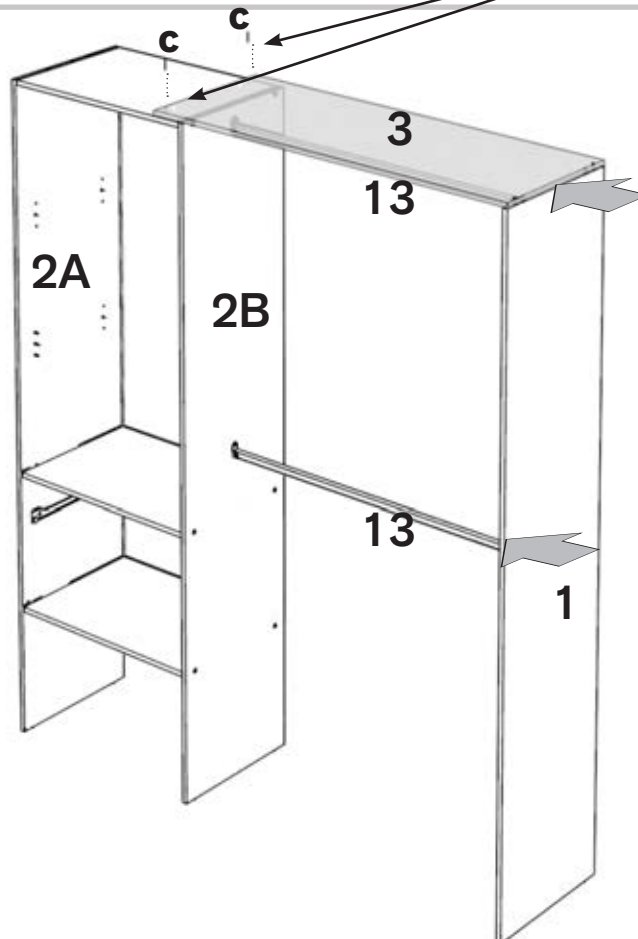

Español

### **Atención !!!**

Antes de fijar el mueble a la pared compruebe su resistencia y naturaleza. En caso de que se suministren tacos y tornillos con el producto, éstos se destinan únicamente a los muros hechos con materiales sólidos y homogéneos. En caso de duda, consulte a un especialista, debiendo efectuar este montaje un operario especializado.

**ADVERTENCIA:** Con el fin de evitar la caída/vuelco, este mueble debe utilizarse siempre con el dispositivo de fijación de pared suministrado. Pueden producirse lesiones graves o fatales si vuelca un mueble. Para evitar que vuelque este mueble, debe fijarse permanentemente a la pared.

Deutsch

### **Achtung!!!**

Bevor Sie die Möbel an der Wand befestigen, überprüfen Sie deren Festigkeit und Beschaffenheit. Falls Dübel und Schrauben im Lieferumfang des Produkts enthalten sind, sind diese nur für Wände aus festen und homogenen Materialien vorgesehen. Wenden Sie sich im Zweifelsfall an einen Fachmann, und ein Fachmann muss diese Montage durchführen.

**WARNUNG:** Wenn Möbelstücke umkippen, können ernste oder lebensgefährliche Verletzungen durch Einklemmen die Folge sein. Um zu verhindern, dass das Möbelstück umkippt, muss es fest an der Wand verankert werden.

Italiano

### **Attenzione!!!**

Prima di fissare i mobili al muro, verifica prima la tipologia e resistenza del muro. Se viti e tasselli sono inclusi nell'offerta, essi sono utilizzabili solamente per i muri fatti di un certo tipo di materiale.

**AVVERTENZA:** Se il mobile si ribalta può causare lesioni da compressione serie o fatali. Per prevenire il rischio che il mobile si ribalti, quest'ultimo deve essere fissato permanentemente alla parete. Gli accessori per il fissaggio alla parete non sono inclusi perché pareti di materiali diversi richiedono tipi diversi di accessori di fissaggio. Usa sistemi di fissaggio adatti alle pareti della tua casa. Per maggiori dettagli, rivolgiti a un rivenditore specializzato.

English

### **Warning !!!**

Before suspending or fixing to the wall check the type and strength of the wall. If the screws and dowels are supplied with the product, these are only intended for walls made of solid and homogeneous materials. In the case of doubts, contact a specialist, the installation must be performed by a competent person.

**WARNING:** Serious or fatal crushing injuries can occur from furniture tip-over. To prevent this furniture from tipping over, it must be permanently fixed to the wall.

Français

### **Attention!!!**

Avant de suspendre le meuble ou de le fixer au mur, vérifiez au préalable le type et la résistance du mur. Utilisez les chevilles et les vis adaptées au type de mur. En cas de doute, consultez un spécialiste et un opérateur spécialisé doit effectuer cet assemblage.

**AVERTISSEMENT:** Risque de blessure grave en cas de chute du meuble. Pour éviter que ce meuble ne bascule, il faut le fixer au mur de façon permanente.

Português

### **Atenção!!!**

Antes de pendurar ou fixar o móvel na parede, verifique com antecedência a sua natureza e resistência. Se o produto for acompanhado de buchas e parafusos, estes destinam-se só às paredes feitas com materiais sólidos e homogéneos. Em caso de dúvida, consulte um especialista. A montagem deve ser efetuado por uma pessoa competente.

**IMPORTANTE:** As quedas de móveis podem originar esmagamento ou morte. Estes móveis devem ser fixados à parede para evitar possíveis quedas.

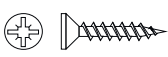
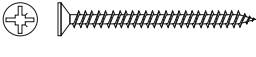
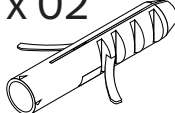
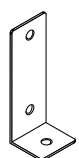

<b>11</b>	<b>B x 02</b>  3.5 x 15 mm.	<b>D x 02</b>  4.5 x 45 mm.	<b>H x 02</b>  8 mm.	<b>J x 02</b> 
-----------	--	--	---	--

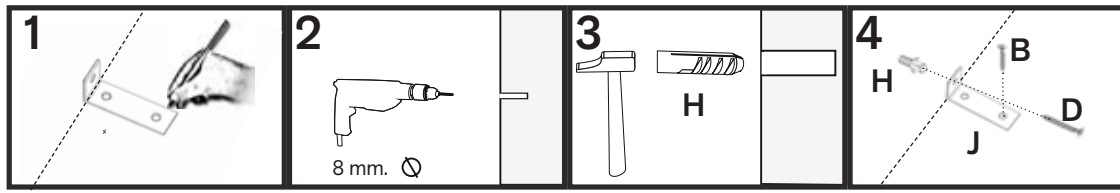

## Option B

