

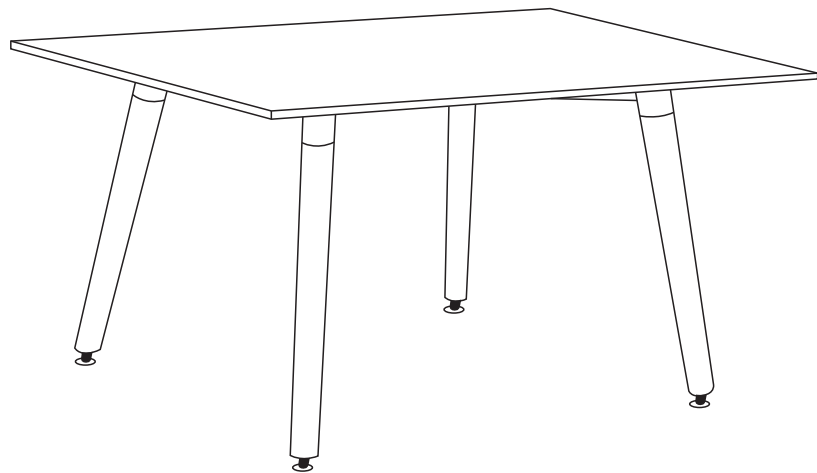

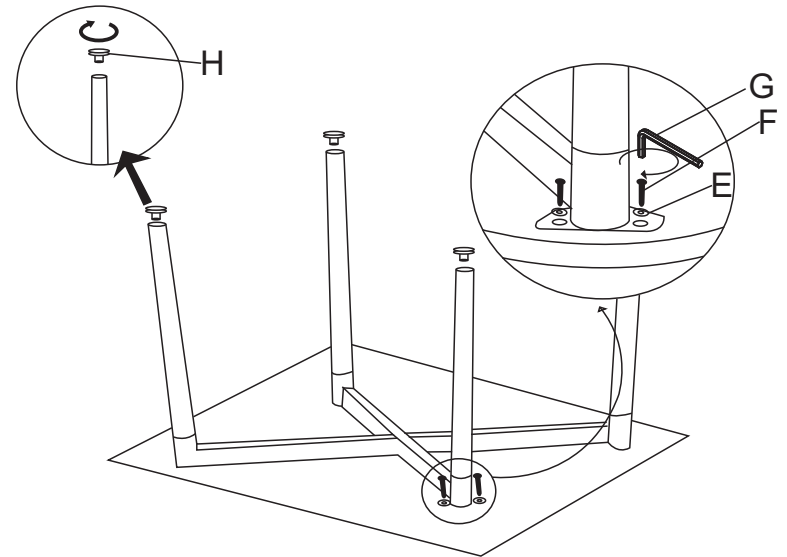

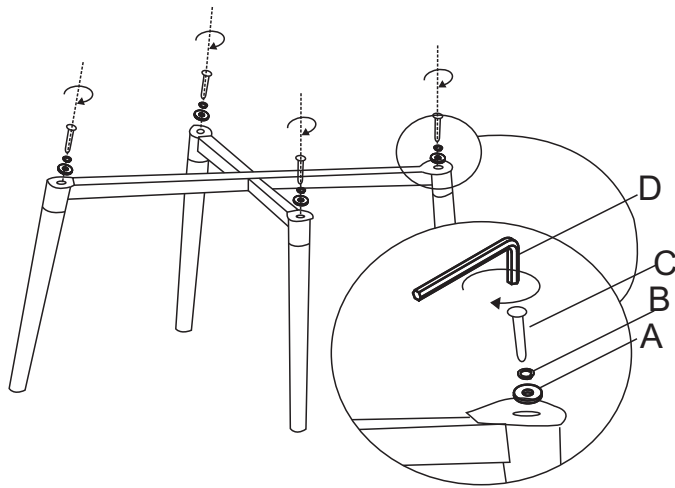











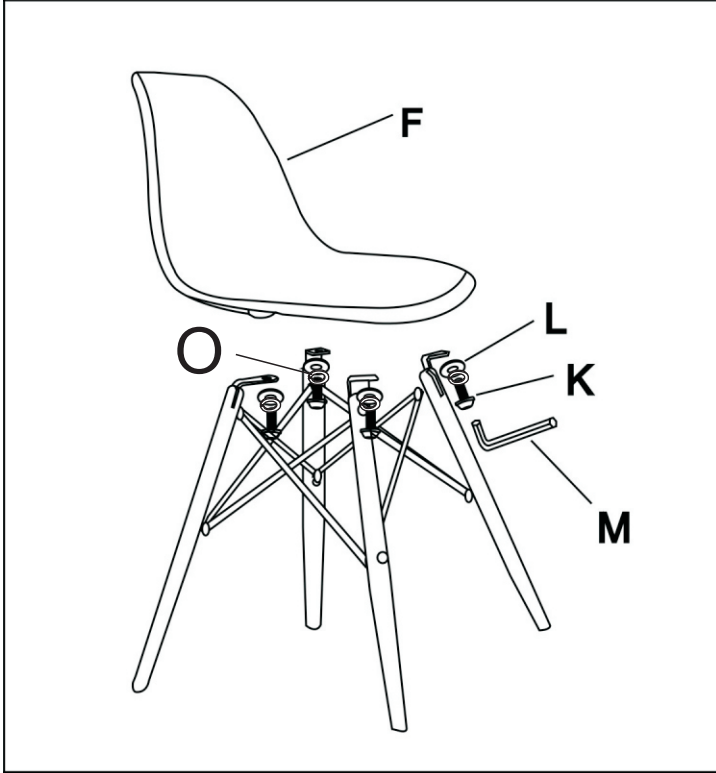
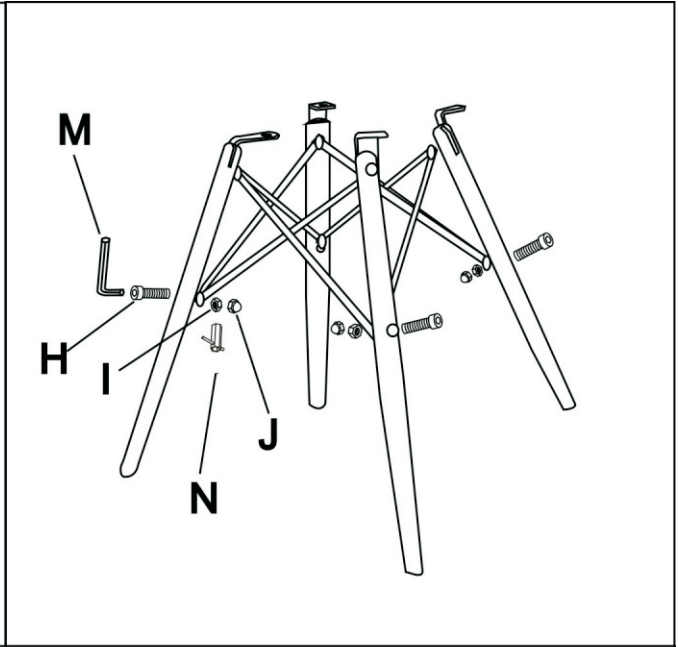
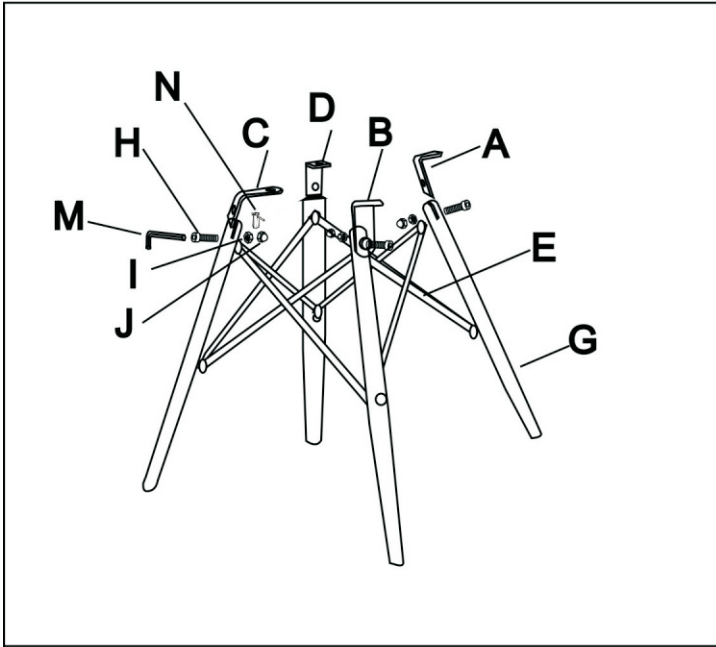







ASSEMBLING PROCESS



Ax4 	Bx4 	Cx4 
Dx1 	Ex8 	Fx8 
Gx1 	Hx4 	



A	 1pcs	F	 1pcs	K	 4pcs 6*13mm
B	 1pcs	G	 4pcs	L	 4pcs
C	 1pcs	H	 8pcs 6*36mm	M	 1pcs
D	 1pcs	I	 8pcs	N	 1pcs
E	 1pcs	J	 8pcs	O	 4pcs