

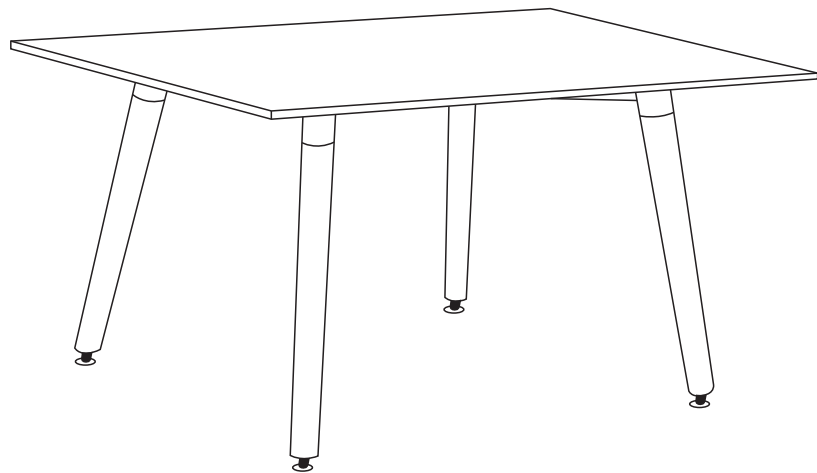

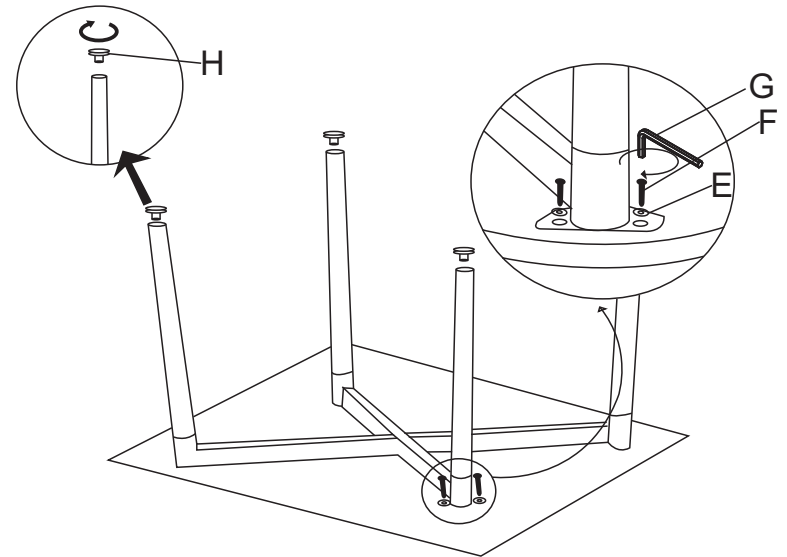

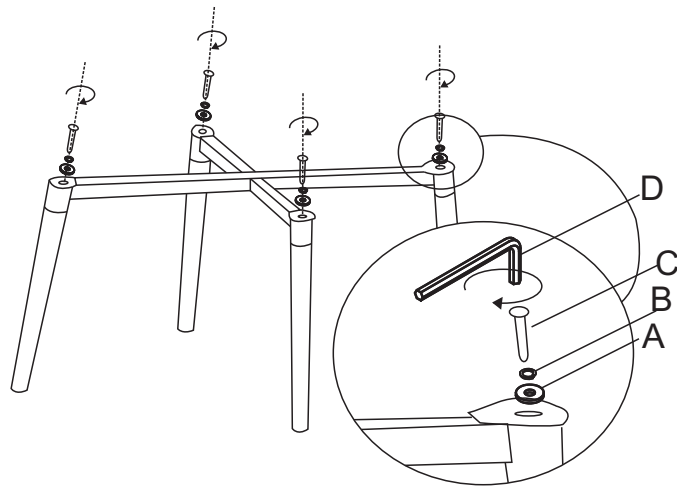











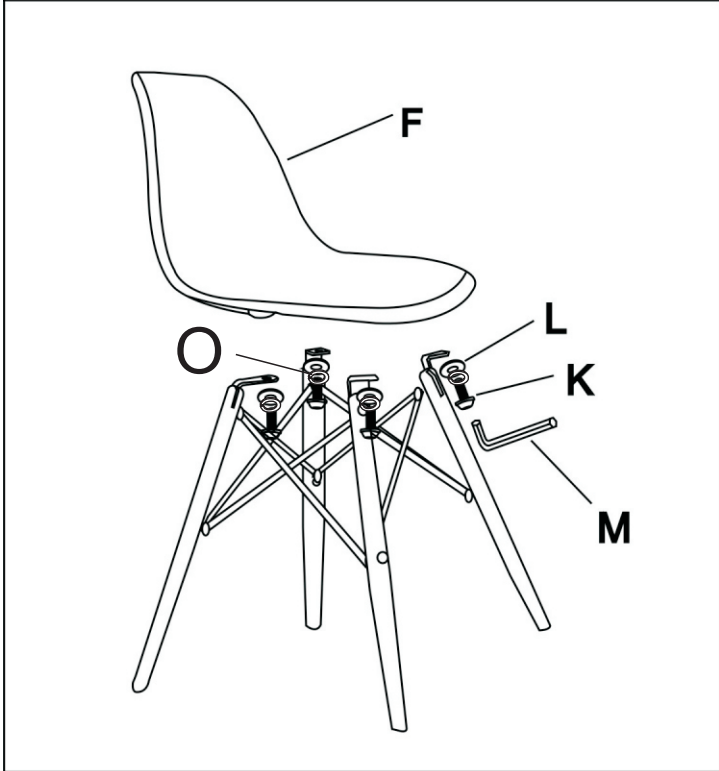
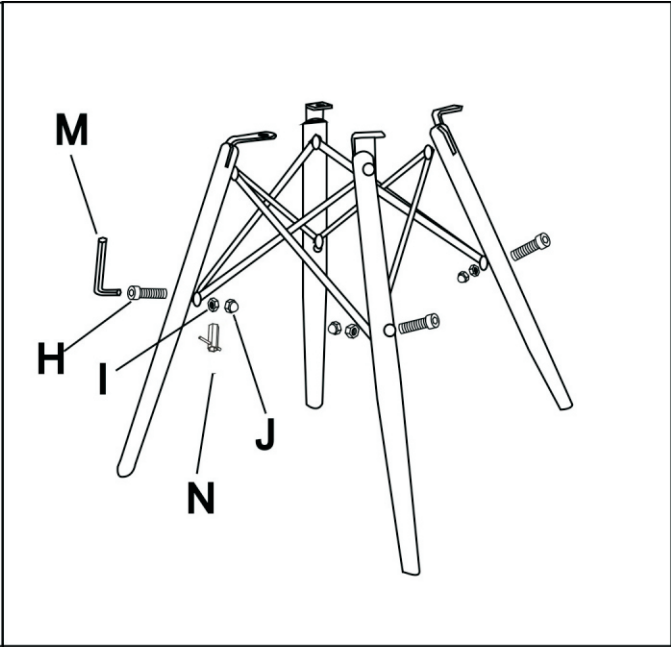
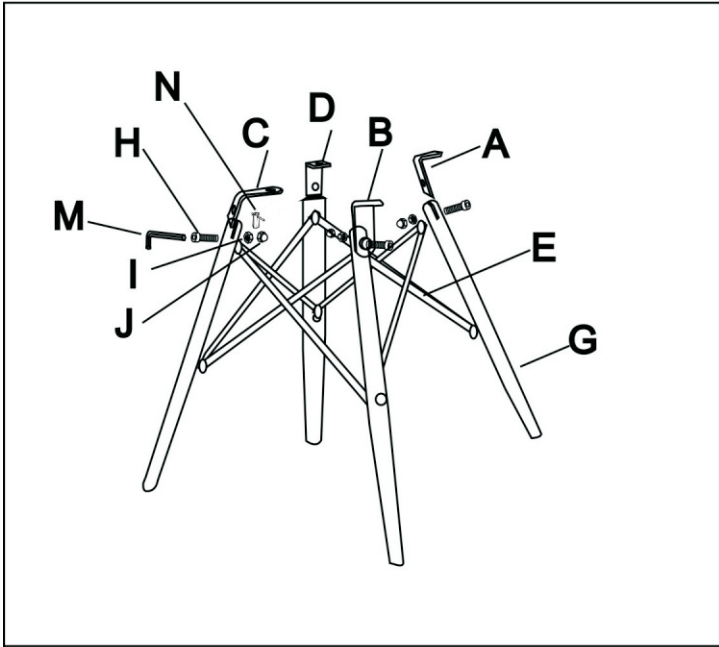







# ASSEMBLING PROCESS



Ax4 	Bx4 	Cx4 
Dx1 	Ex8 	Fx8 
Gx1 	Hx4 	



<b>A</b>	 1pcs	<b>F</b>	 1pcs	<b>K</b>	 4pcs 6*13mm
<b>B</b>	 1pcs	<b>G</b>	 4pcs	<b>L</b>	 4pcs
<b>C</b>	 1pcs	<b>H</b>	 8pcs 6*36mm	<b>M</b>	 1pcs
<b>D</b>	 1pcs	<b>I</b>	 8pcs	<b>N</b>	 1pcs
<b>E</b>	 1pcs	<b>J</b>	 8pcs	<b>O</b>	 4pcs